



S-Danoise 1505-LA40

Type : Applique/Flushmount

Matériaux/Materials : Aluminium powder coat • Verre/
Glass

Specifications : E26 base LED, 120 volts, dimmable

Ampoule/Bulb : Tala Sphere I 3.8 Watt • 220 Lumens •
2000K to 2800K Dim to warm

Poids/Weight: 8 lb.

Garantie/Warranty : 2 ans/years

Certification : 

Usage intérieur seulement/Indoor use only

Lien 3D/link : [Cliquez ici/Click here](#)

Colors/Couleurs :



Matt White
WTM



Matt Black
BKM



Matt Beige
BGM



Matt Linen
LIM

Pour tous les fichiers 3D, incluant CAD, Revit et IES,
visitez le www.luminaireauthentik.com / For 3D drawings of all products,
including CAD, Revit and IES files, please visit www.luminaireauthentik.com

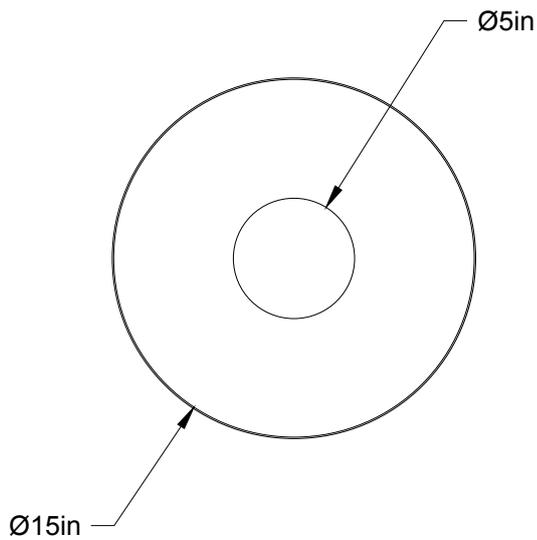

Avant/Front

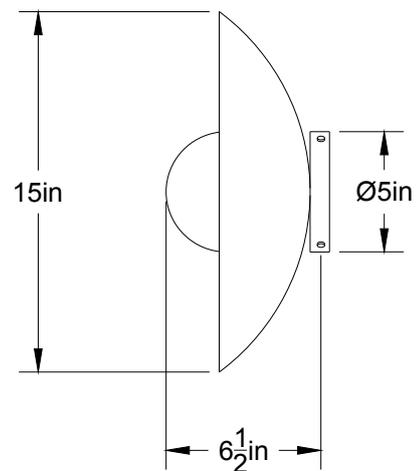

Côté/Side