



## Nube Marrone 0806-LA00-L

Type : Suspension/Pendant

Matériaux/Materials : Aluminium powder coat •  
Verre/Glass

Specifications : E26 base LED, 120 volts, dimmable

Ampoule/Bulb : Tala Sphere I 3.8 Watt • 220 Lumens •  
2000K to 2800K Dim to warm

Poids/Weight : 5 lb.

Garantie/Warranty : 2 ans/years

Certification :

Usage intérieur seulement/Indoor use only

Lien 3D/link : [Cliquez ici/Click here](#)

Pour tous les fichiers 3D, incluant CAD, Revit et IES,  
visitez le [www.luminaireauthentik.com](http://www.luminaireauthentik.com) / For 3D drawings of all products,  
including CAD, Revit and IES files, please visit [www.luminaireauthentik.com](http://www.luminaireauthentik.com)

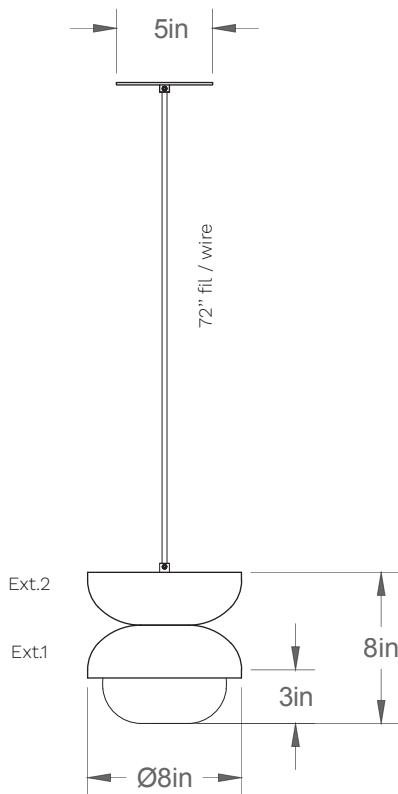

Avant/Front

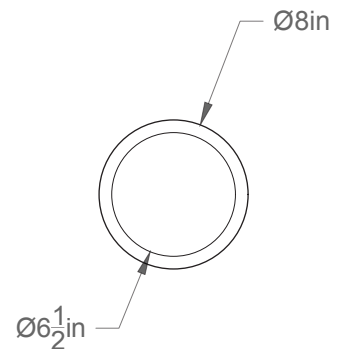

Dessus/Top

## Abat-jour/Shade Ext-2.

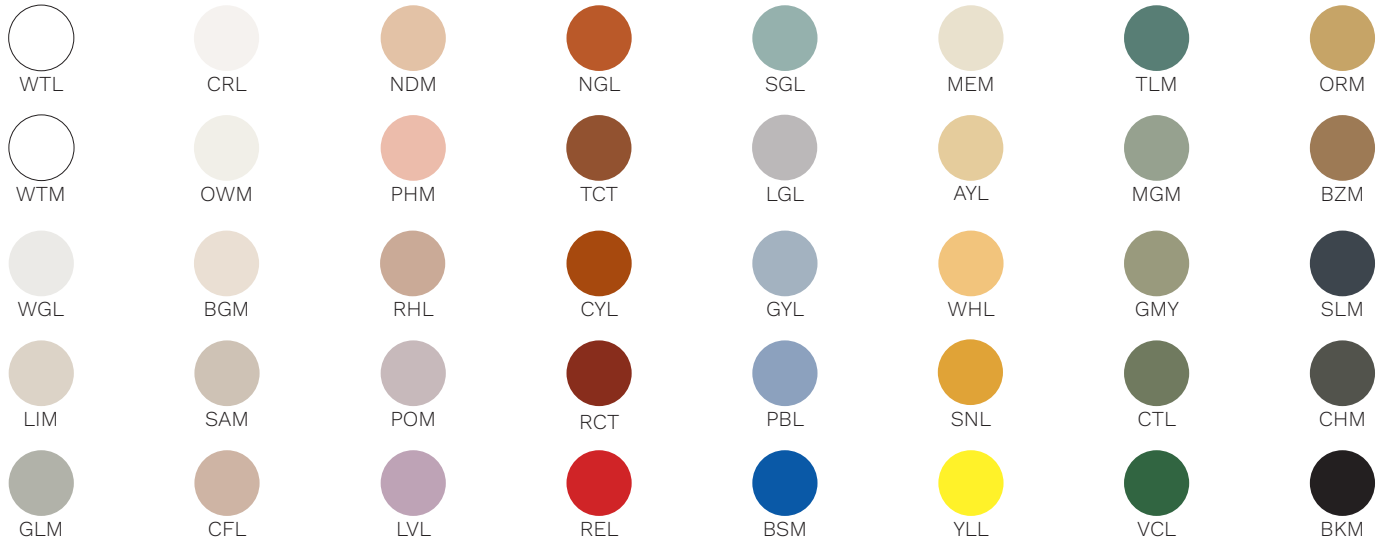

## Abat-jour/Shade Ext-1.

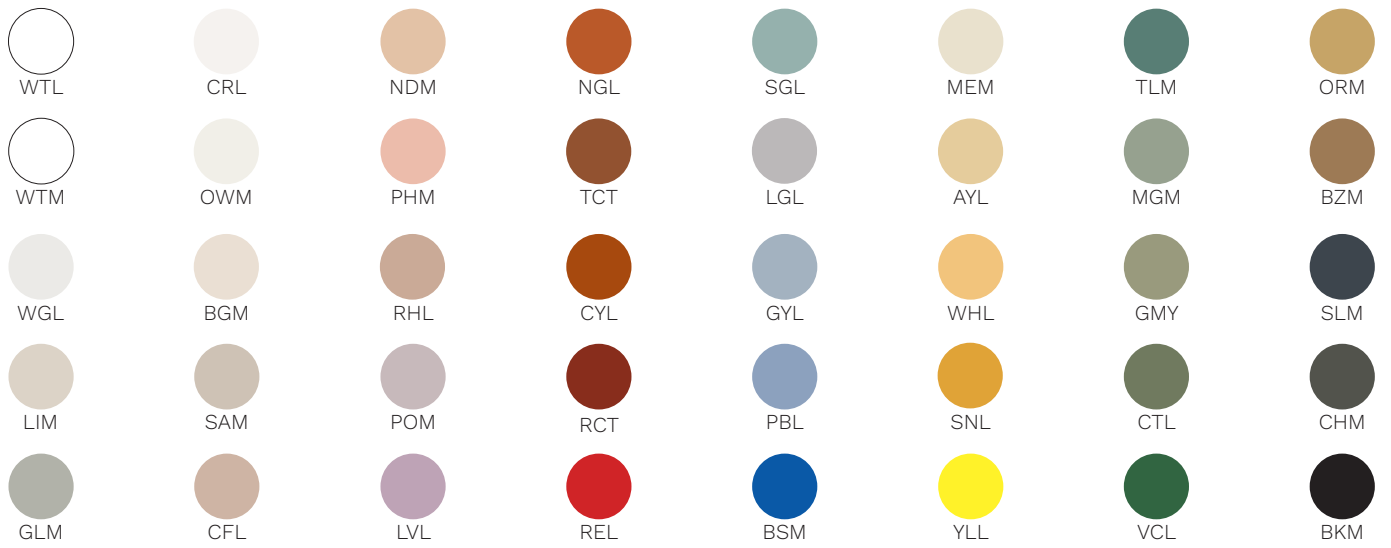

## Abat-jour/Shade Int.



## Boules de verre/Glass ball

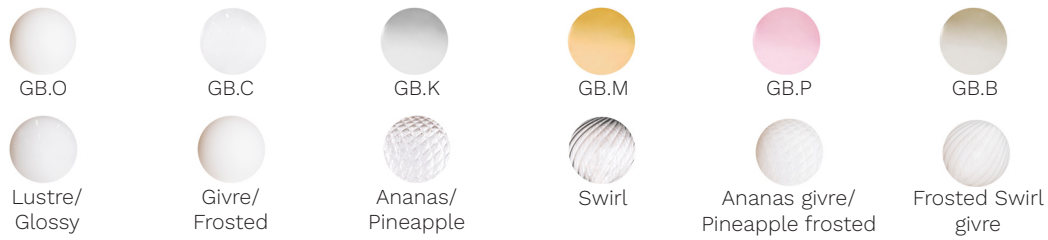

## Fil/Wire



TBK



TWT



TCH



TWG



TCR



TND



TCP



TCT



TOR

## Quincaillerie/Hardware



BRR



NIR



Même A-J/  
Same as shade



Même fil/  
Same as wire

## Canopy style + colour



BRR (\$)



WTM



Même A-J/  
Same as shade



Même fil/  
Same as wire

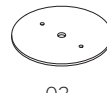

03

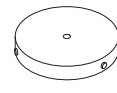

04 (\$)

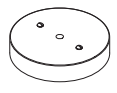

01