

## Coquelicot 11-LA100-M

Type : Sur pied/Free standing

Matériaux/Materials : Aluminium powder coat

Specifications : E26 base LED, 120 volts, dimmable

Ampoule/Bulb : Tala Sphere I 3.8 Watt • 220 Lumens • 2000K to 2800K Dim to warm

Poids/Weight : 10 lb.

Garantie/Warranty : 2 ans/years

Certification : 

Usage intérieur seulement/Indoor use only

Page produit/Product page : [Cliquez ici/Click here](#)

\*Doit être livré sur palette /  
Must be shipped on a pallet.

Pour tous les fichiers 3D, incluant CAD, Revit et IES, visitez le [www.luminaireauthentik.com](http://www.luminaireauthentik.com) / For 3D drawings of all products, including CAD, Revit and IES files, please visit [www.luminaireauthentik.com](http://www.luminaireauthentik.com)

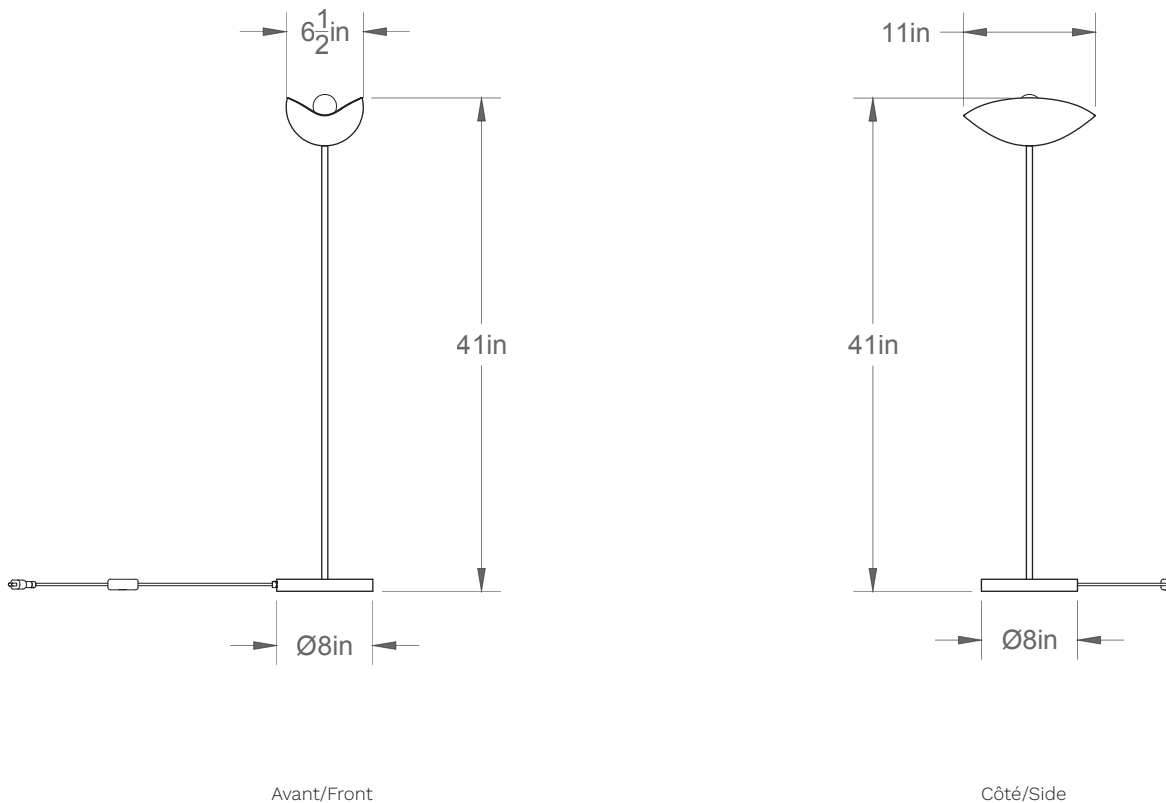

## Abat-jour/Shade Ext.



WTL



CRL



NDM



NGL



SGL



MEM



TLM



ORM



WTM



OWM



PHM



TCT



LGL



AYL



MGM



BZM



WGL



BGM



RHL



CYL



GYL



WHL



GMY



SLM



LIM



SAM



POM



RCT



PBL



SNL



CTL



CHM



GLM



CFL



LVL



REL



BSM



YLL

















VCL



BKM

## Tige/Rod

|  |  |  |  |  |  |  |  |
|--|--|--|--|--|--|--|--|
| <br>WTL | <br>CRL | <br>NDM | <br>NGL | <br>SGL | <br>MEM | <br>TLM | <br>ORM |
| <br>WTM | <br>OWM | <br>PHM | <br>TCT | <br>LGL | <br>AYL | <br>MGM | <br>BZM |
| <br>WGL | <br>BGM | <br>RHL | <br>CYL | <br>GYL | <br>WHL | <br>GMY | <br>SLM |
| <br>LIM | <br>SAM | <br>POM | <br>RCT | <br>PBL | <br>SNL | <br>CTL | <br>CHM |
| <br>GLM | <br>CFL | <br>LVL | <br>REL | <br>BSM | <br>YLL | <br>VCL | <br>BKM |

## Base Colour

|  |   |  |
|--|---|--|
| <br>BRR (\$) | <br>Même A-J/<br>Same as shade | <br>Même tige/<br>Same as rod |
|--|---|--|

## Fil/Wire

|  |  |  |  |  |  |  |  |
|--|--|--|--|--|--|--|--|
| <br>TBK | <br>TWT | <br>TCH | <br>TSL | <br>TCR | <br>TND | <br>TCT | <br>TAM |
|--|--|--|--|--|--|--|--|